

ROTTLER

THE CUTTING EDGE

H85AXY OPTIONAL EQUIPMENT CATALOG



ORDERING PROCEDURE

Contact your regional Rottler sales rep for assistance in ordering optional equipment, replacement parts, or tooling.

If you are unable to contact your regional Rottler sales rep, call the factory at 253-872-7050 and ask to speak to the parts sales specialists.

Have the following information handy to expedite the ordering process:

1. Your name, business name, and contact number
2. Customer number
3. If you don't have a customer number, your billing address
4. Shipping address if different from billing address
5. Machine model and serial number
6. Part number and description of what you want to order
7. Preferred method of shipment

You may also contact us via e-mail with the above information. Send e-mail requests to: parts@rottlermfg.com

In some cases you may be requested to send a photo of the part you are ordering if it is a replacement part, or doesn't appear in the database.

If you are unsure which part you need to order, contact our service department and ask to speak to one of our service consultants. They will assist you in determining which part you require.

THERE IS A MINIMUM ORDER OF \$25.00



Contents

Optional Fixturing..... 1

514-14-60 Automatic Programmable Roll Over Fixture 1

514-7A Manual Indexable Roll Over Fixture..... 2

502-1-30H Clamp Arm Assembly..... 2

11115 2” (50mm) X 3” (75mm) Parallels..... 3

11112 Universal 8” (203mm) Heavy Duty T-Slot Parallels..... 3

11114 Universal 16” (405mm) Heavy Duty T-Slot Parallels..... 4

Fixture for Honing Multiple Cylinder Liners (4 Liners) 5

514-11-5 Cylinder Liner Honing Fixture..... 5

514-11-6 Fixture Plate, CAT 3400..... 5

514-11-7 Fixture Plate, CAT 3500..... 6

514-11-4 Fixture Plate, CAT C175 6

Optional Coolant and Filter Equipment..... 7

514-4-71C Synthetic Coolant..... 7

514-4-71D Coolant Refractor 7

514-2-42C Dual Gradient 50-5 Micron Replacement Filter Cartridge..... 7

Optional Rottler Precision Hone Heads, Sleeves and Stone Holders 8

514-9J Medium Rottler Precision 4 Stone Holder Hone Head Assembly 8

514-10-13A Stone Holders 8

514-10-13F Stone Holders..... 8

514-10-13B Stone Holders 8

514-10-13G Stone Holders..... 9

514-10-13C Stone Holders 9

514-10-13H Stone Holders 9

514-10-13D Stone Holders 9

514-9Q Large Rottler Precision Heavy Duty 6 Stone Holder Hone Head Assembly 10

514-9S Large Rottler Precision Heavy Duty 6 Stone Holder Hone Head Assembly..... 10

514-9-4E Sleeve Assembly 10

514-9-31J Stone Holders..... 11

514-9-31A Stone Holders 11

514-9-31B Stone Holders 11

514-9-4F Sleeve Assembly..... 12

514-9-31C Stone Holders 12

514-9-31D Stone Holders 12



514-9-31E Stone Holders 13

514-9-4G Sleeve Assembly 13

514-9-31F Stone Holder..... 13

514-9-31G Stone Holder 14

514-9-31H Stone Holder 14

514-9-31K Stone Holder 14

514-9-31L Stone Holder..... 15

514-9-31M Stone Holder..... 15

514-9-31N Stone Holder 15

514-9-31P Stone Holder 16

514-9-31Q Stone Holder 16

514-9-31R Stone Holder 16

514-9-31S Stone Holder 17

Diamond Abrasives for Rottler Precision 6 Stone Holder Hone Heads 17

514-9-32F Diamond Stones, 80 grit..... 17

514-9-32R Diamond Stones 80 grit 17

514-9-32W Diamond Stones, 140/170 grit..... 18

514-9-32K Diamond Stones, 170/200 grit 18

514-9-32J Diamond Stones, 270/325 grit..... 18

514-9-32E Diamond Stones, 325/400 grit..... 18

514-9-32C Diamond Stones, 500 grit 19

514-9-32L Diamond Stones, 550 grit..... 19

514-9-32G Diamond Stones, 600 grit 19

514-9-33 Diamond Stones, 800 grit..... 19

514-9-33C Diamond Stones, 800 grit 20

514-9-33J Diamond Stones, 1200 grit..... 20

514-9-33B Diamond Stones, 270/325 grit 20

514-9-32D Diamond Stones, 325/400 grit 21

514-9-33A Diamond Stones, 800 grit 21

514-9-35C CBN Stones, 320 grit..... 21

514-9-35D CBN Stones, 400 grit..... 21

514-9-35B CBN Stones, 600 grit..... 21

514-9-14H Brushes, for Plateau Finishing..... 22

514-9-14Y Brushes, for Plateau Finishing..... 22

514-9P Large Rottler Precision Heavy Duty 4 Stone Holder Hone Head Assembly..... 23



514-9R Large Rottler Precision Heavy Duty 4 Stone Holder Hone Head Assembly 23

514-9-4A Sleeve Assembly 23

514-9-6J Stone Holders..... 24

514-9-6A Stone Holders 24

514-9-6B Stone Holders 24

514-9-4B Sleeve Assembly 25

514-9-6C Stone Holders 25

514-9-6D Stone Holders 25

514-9-6E Stone Holders 26

514-9-4C Sleeve Assembly 26

514-9-6F Stone Holders..... 26

514-9-6G Stone Holders 27

514-9-6H Stone Holders 27

514-9-6K Stone Holders 27

514-9-6L Stone Holders..... 27

514-9-6M Stone Holders..... 28

514-9-6N Stone Holders 28

514-9-6P Stone Holders 28

514-9-6Q Stone Holders 29

514-9-6R Stone Holders 29

514-9-6S Stone Holders 29

514-9-14F Diamond Stones, 80 grit..... 30

514-9-14R Diamond Stones, 80 grit 30

514-9-21R Diamond Stones, 80 grit 30

514-9-14W Diamond Stones, 140/170 grit..... 30

514-9-21W Diamond Stones, 140/170 grit..... 31

514-9-14K Diamond stones, 170/200 grit..... 31

514-9-14M Diamond Stones, 170/200 grit 31

514-9-21M Diamond stones, 170/200 grit 31

514-9-14J Diamond Stones, 270/325 grit..... 31

514-9-14T Diamond Stones, 270/325 grit..... 32

514-9-14Z Diamond Stones, 270/325 grit..... 32

514-9-14E Diamond Stones, 325/400 grit..... 32

514-9-14Q Diamond Stones, 325/400 grit 32

514-9-14X Diamond Stones, 325/400 grit..... 32



514-9-14V Diamond Stones, 400 grit..... 33

514-9-14C Diamond Stones, 500 grit 33

514-9-14P Diamond Stones, 500 grit..... 33

514-9-14D Diamond Stones, 325/400 grit 33

514-9-14U Diamond Stones, 500 grit 33

514-9-14L Diamond Stones, 550 grit..... 34

514-9-14N Diamond Stones, 550 grit 34

514-9-14G Diamond Stones, 600 grit 34

514-9-14S Diamond Stones, 600 grit..... 34

514-9-21G Diamond Stones, 800 grit 34

514-9-21H Diamond Stones, 1000 grit 35

514-9-21J Diamond Stones, 1200 grit..... 35

CBN Stones for Super Finishing with Rottler Precision 4 and 6 Stone Holder

Hone Heads..... 35

514-9-35C CBN Stones, 320 grit..... 35

514-9-35D CBN Stones, 400 grit..... 35

514-9-35B CBN Stones, 600 grit..... 35

514-9-14H Brushes, for Plateau Finishing..... 36

514-9-14Y Brushes, for Plateau Finishing..... 36

514-9-18P Special Red Finish Diamonds 37

514-9-18N Silicone Abrasive Exposing Stones 37

514-9-21 Polishing Felt Pads..... 37

514-9-21F Silicone Paste..... 37

514-9M Hone Head, Dual Stage Rough & Finish (10 Stone)..... 38

110-162R Dual Stage Diamond Stones 38

110-163R Dual Stage Diamond Stones 38

110-163R-01 Dual Stage Diamond Stones..... 38

110-163R-03 Dual Stage Diamond Stones..... 39

110-164R Dual Stage Diamond Stones 39

110-164R-01 Dual Stage Diamond Stones..... 39

110-164R-03 Dual Stage Diamond Stones..... 39

124-24 Brush Set, Dual Stage Hone Head..... 40

124-25 Brush Set, Dual Stage Hone Head..... 40

124-26 Brush Set, Dual Stage Hone Head..... 40

514-9N Hone Head, Single Stage (12 Stone)..... 41



110-171-01 Single Stage Diamond Stones 41

110-171-02 Single Stage Diamond Stones 41

110-171-03 Single Stage Diamond Stones 41

LO-6568-161 Hone Head, Single Stage (6 Stone) 42

110-174-01 Diamond Stones 42

LO-6568-160 Hone Head, Single Stage..... 43

110-173-01 Diamond Stones 43

Optional Measuring Equipment 44

201 Mitutoyo Surface Tester SurfTest 201 44

514-8-27 Stone Depth Scale and Holder Assembly (inch) 44

514-8-27F Stone Depth Scale and Holder Assembly (metric) 44

Camera & Software To View Cross Hatch Angle 45

514-14-29A Camera 45

514-14-29B Software Package..... 45

Adapter for Pin Hone Mandrels..... 46

514-9V Adapter 46

Safety Shut Down Protection System 47

514-13-26 Laser Light Curtain 47

Optional Fixturing

514-14-60 Automatic Programmable Roll Over Fixture

For In-Line and V Blocks up to 31" (787mm) overall length, allows H85AXY machine to hone complete V block automatically unattended

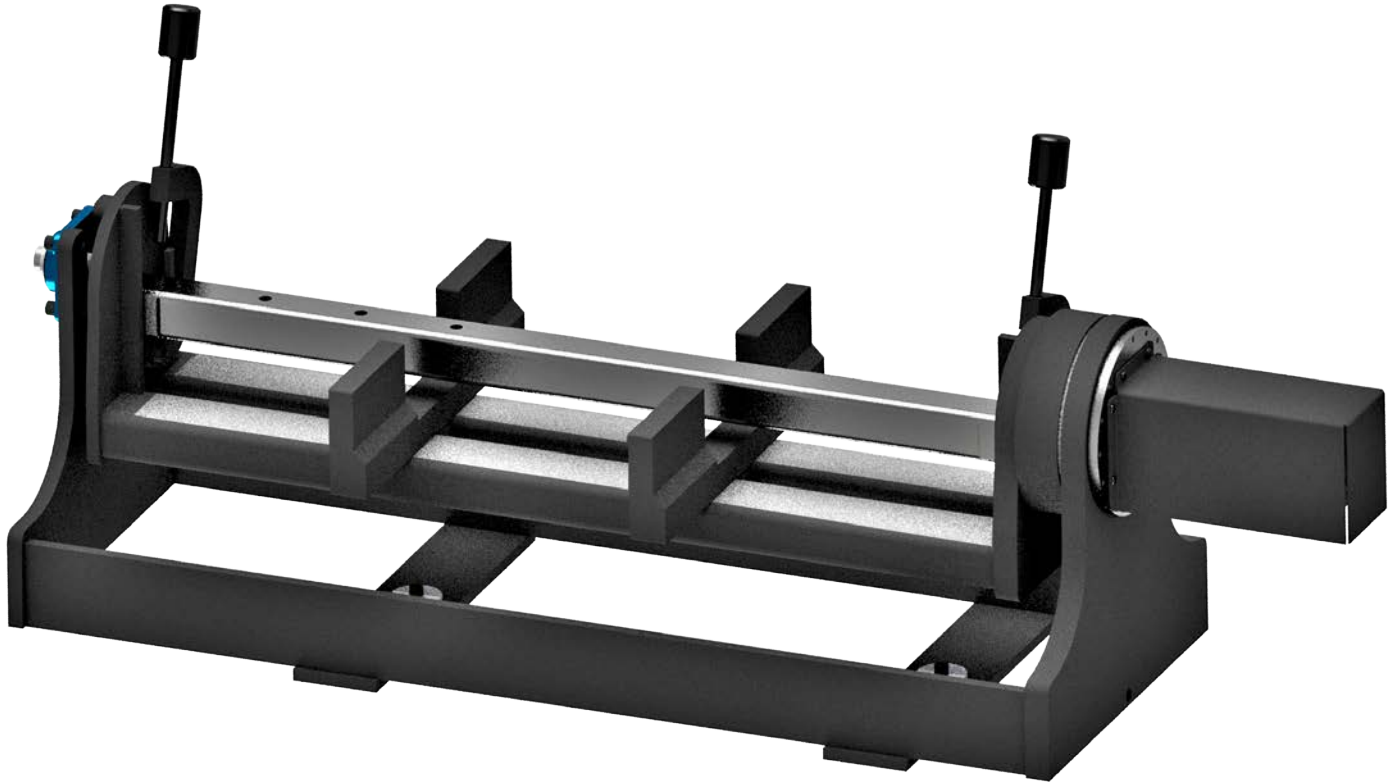

514-7A Manual Indexable Roll Over Fixture

For small to medium size In-line and V Blocks up to 31" (787mm) overall length

**502-1-30H Clamp Arm Assembly**

Set of 2, for blocks without main caps when using manual Roll Over Fixture and large in-line blocks without roll over fixture, max length of block 50" 1270mm



11115 2" (50mm) X 3" (75mm) Parallels

For general purpose machine work such as setting up small in-line blocks such as motorcycle or small single cylinders such as Harley

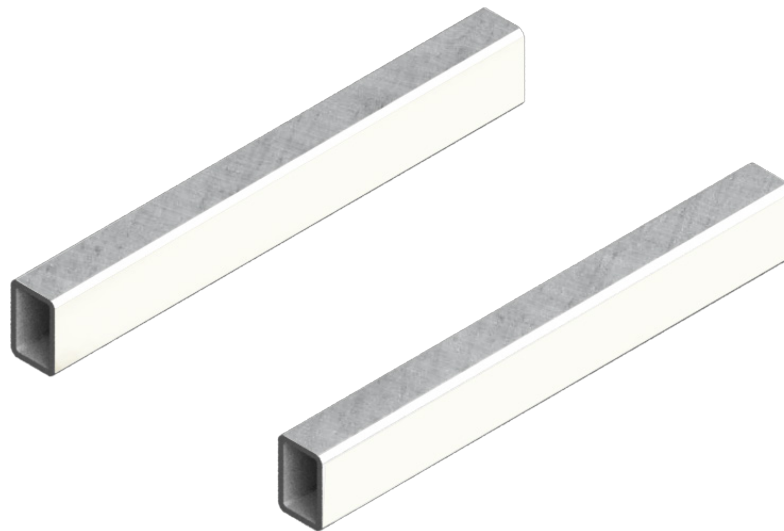
**11112 Universal 8" (203mm) Heavy Duty T-Slot Parallels**

For general purpose machine work such as setting up small in-line blocks such as motorcycle or small single cylinders such as Harley

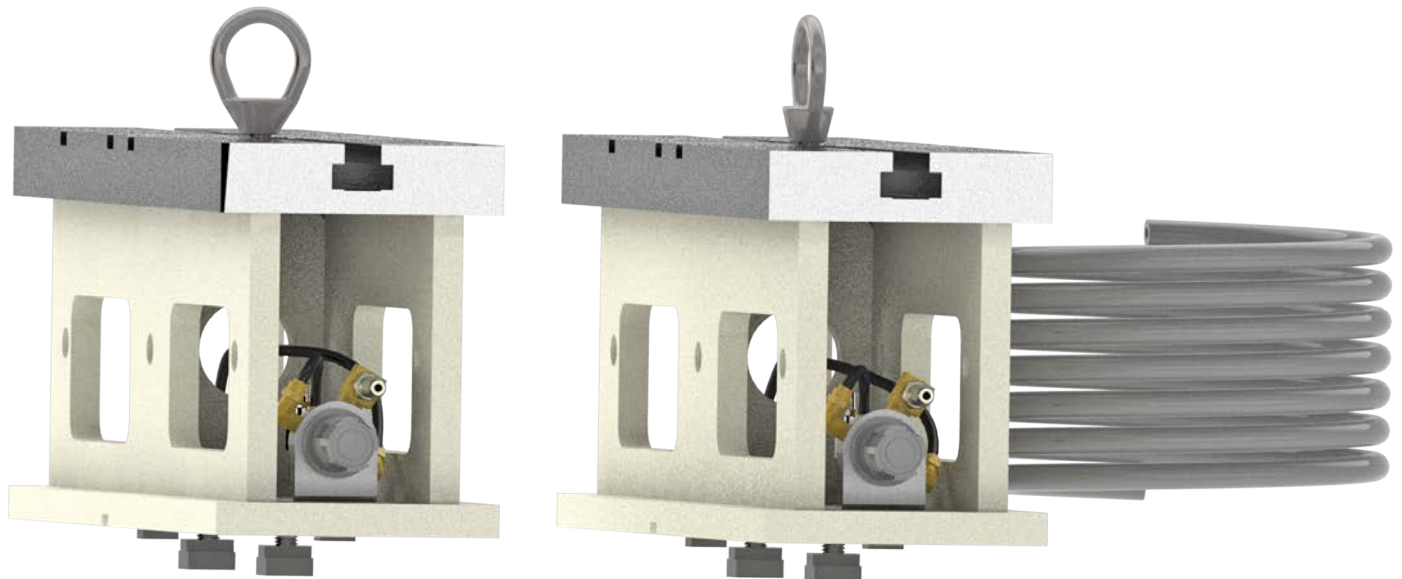

11114 Universal 16" (405mm) Heavy Duty T-Slot Parallels

For general purpose machine work such as setting up small in-line blocks such as motorcycle or small single cylinders such as Harley

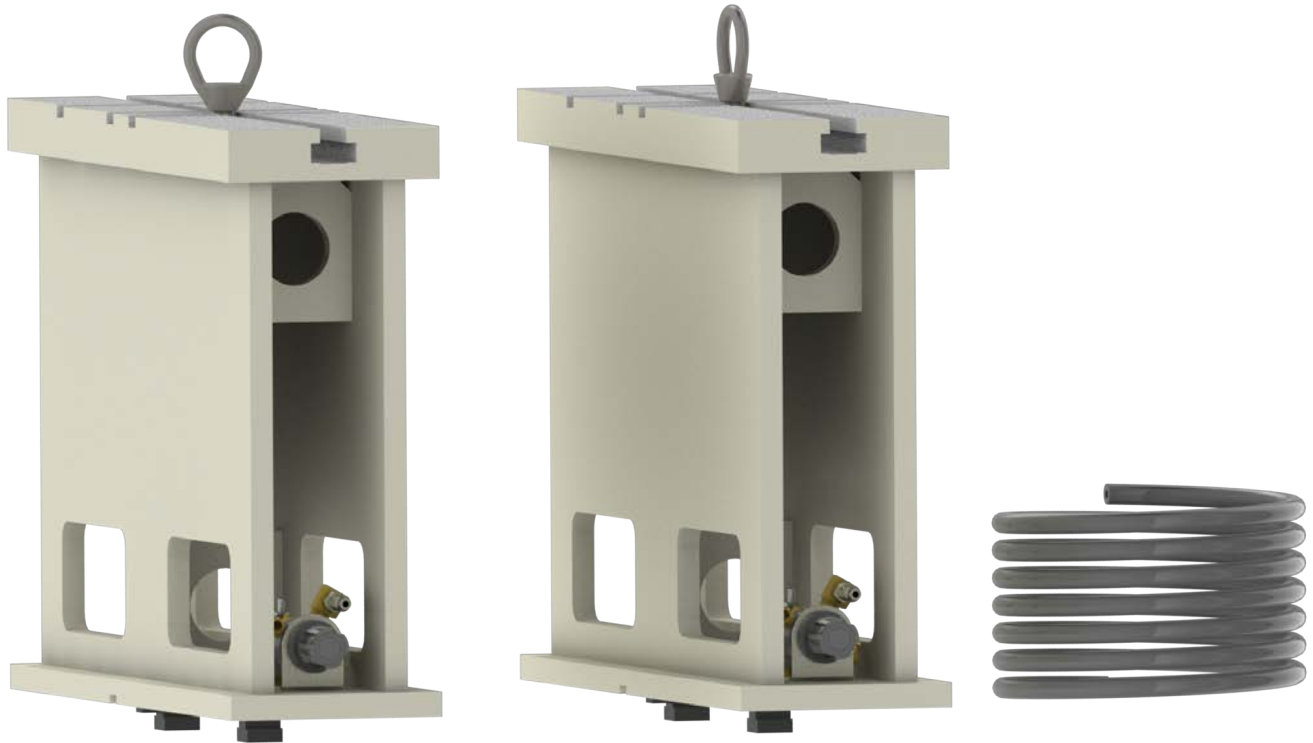

Fixture for Honing Multiple Cylinder Liners (4 Liners)

514-11-5 Cylinder Liner Honing Fixture

(Note: Must order Fixture Plate Separately)

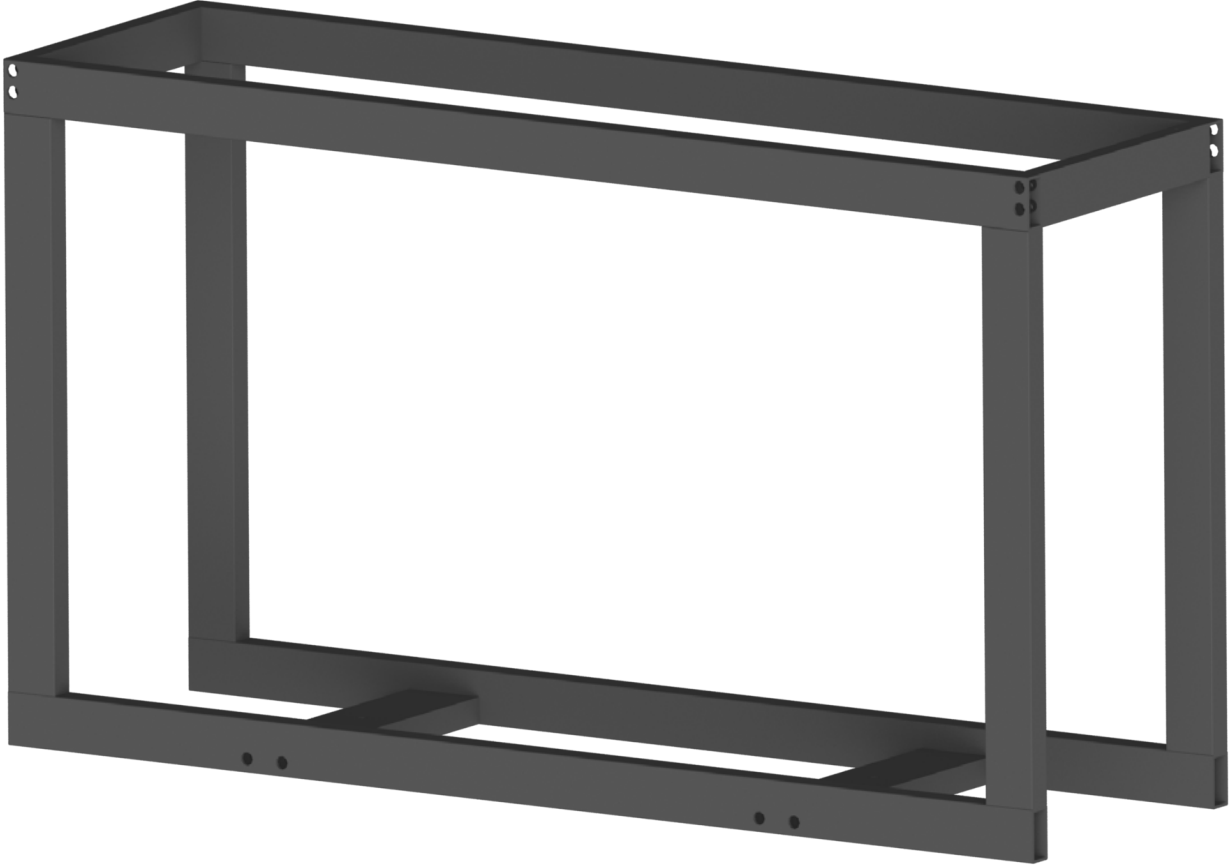

514-11-6 Fixture Plate, CAT 3400

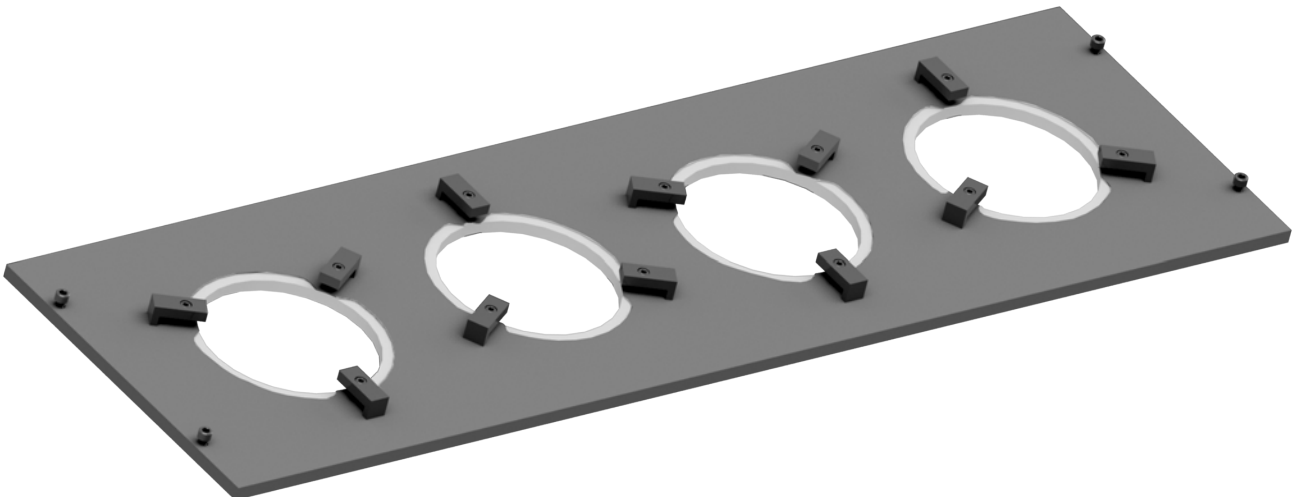

514-11-7 Fixture Plate, CAT 3500

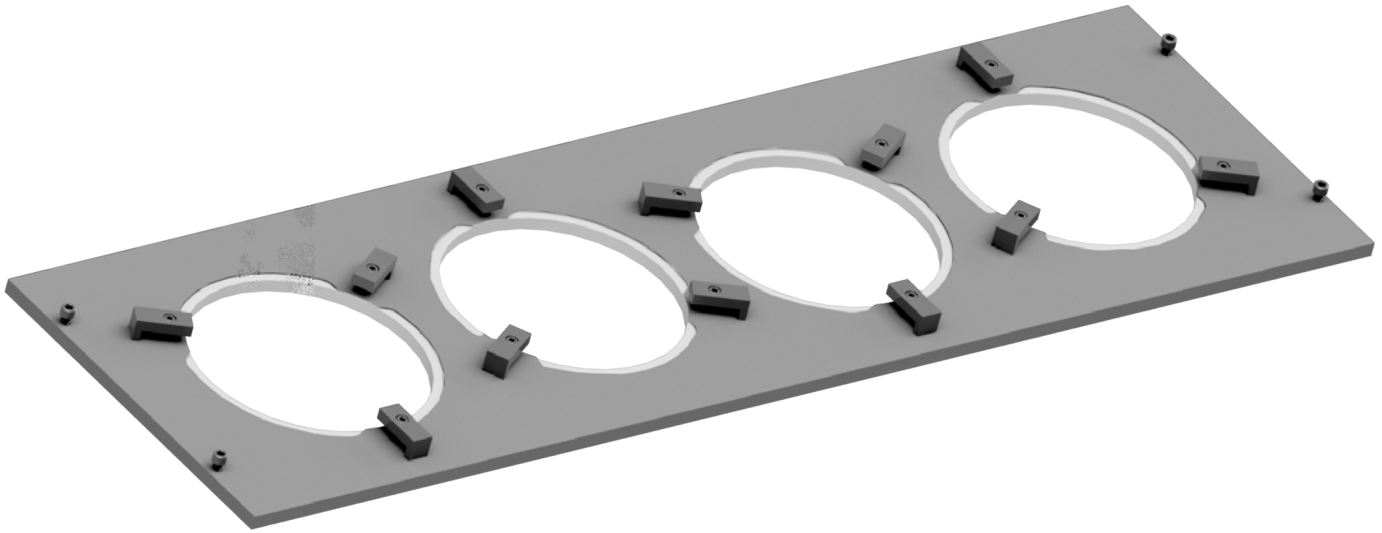

514-11-4 Fixture Plate, CAT C175



Optional Coolant and Filter Equipment

514-4-71C Synthetic Coolant

(for use with diamond stones) 5 gal (20 liter) (mix with water 20:1)



514-4-71D Coolant Refractor

(for measuring synthetic coolant to water mix ratio)



514-2-42C Dual Gradient 50-5 Micron Replacement Filter Cartridge

For standard filter system



Optional Rottler Precision Hone Heads, Sleeves and Stone Holders

Bore diameter ranges listed following are with .312" (7.92mm) height diamond stones. For smaller diameter range, .200" (5.2mm) height diamond stones should be used.

Medium 4 Stone Holder Hone Head 2.34 - 3.05" (59.44 - 77.47mm) Bore Diameter Range

514-9J Medium Rottler Precision 4 Stone Holder Hone Head Assembly

Includes integral sleeve without stone holders - H80 Series Quick Change. Medium hone head available only with 4 stones holders.

Bore diameter ranges listed following are with .312" (7.92mm) height diamond stones. For smaller diameter range, .200" (5.2mm) height diamond stones should be used.



514-10-13A Stone Holders

2.34 - 2.45" (59.44 - 62.23mm), set of 4



514-10-13F Stone Holders

2.44 - 2.55" (61.98 - 64.77mm), set of 4



514-10-13B Stone Holders

2.54 - 2.65" (64.52 - 67.31mm), set of 4



514-10-13G Stone Holders

2.64 - 2.75" (61.37 - 64.16mm), set of 4



514-10-13C Stone Holders

2.74 - 2.85" (69.60 - 72.39mm), set of 4



514-10-13H Stone Holders

2.84 - 2.95" (66.45 - 69.24mm), set of 4



514-10-13D Stone Holders

2.94 - 3.05" (74.68 - 77.47mm), set of 4



Large Hone head is available for 4 and 6 Stone Holder applications as listed following:

Large 6 Stone Holder Hone Head 2.770" - 7.38" (70.36mm - 187.45mm) Bore Diameter Range

514-9Q Large Rottler Precision Heavy Duty 6 Stone Holder Hone Head Assembly

Without sleeves and stone holders - H80 Series Quick Change for cylinders up to 13" (330mm) long



514-9S Large Rottler Precision Heavy Duty 6 Stone Holder Hone Head Assembly

Without sleeves and stone holders - H80 Series Quick Change extended 2" (50mm) for cylinders longer than 13" (330mm)



Sleeves and Stone Holders for above Hone Head Assemblies

Bore diameter ranges listed following are with .312" (7.92mm) height diamond stones. For smaller diameter range, .200" (5.2mm) height diamond stones should be used.

514-9-4E Sleeve Assembly

2.770" - 3.880" (70.36 - 98.55mm)



514-9-31J Stone Holders

2.990 - 3.44" (75.95 - 87.38mm) set of 6 (Requires Sleeve 514-9-4E)

Note: To hone diameter 2.770" (70.36mm) use .200 (5.1mm) height Stone Set with 514-9-6J Stone Holders

**514-9-31A Stone Holders**

3.165 - 3.630" (80.39 - 92.20mm) set of 6 (Requires Sleeve 514-9-4E)

**514-9-31B Stone Holders**

3.415 - 3.880" (86.74 - 98.55mm) set of 6 (Requires Sleeve 514-9-4E)



514-9-4F Sleeve Assembly

3.500 - 4.670" (88.00 - 118.62mm)



514-9-31C Stone Holders

3.665 - 4.130" (93.09 - 104.90mm) set of 6 (Requires Sleeve 514-9-4F)



514-9-31D Stone Holders

3.915 - 4.380" (99.44 - 111.25mm) set of 6 (Requires Sleeve 514-9-4F)



514-9-31E Stone Holders

4.165 - 4.630" (105.79 - 117.60mm) set of 6 (Requires Sleeve 514-9-4F)

**514-9-4G Sleeve Assembly**

4.250 - 7.380" (107.95 - 187.45mm)

**514-9-31F Stone Holder**

4.415 - 4.880" (112.14 - 123.95mm) set of 6 (Requires Sleeve 514-9-4G)



514-9-31G Stone Holder

4.665 - 5.130" (118.49 - 130.30mm) set of 6 (Requires Sleeve 514-9-4G)

**514-9-31H Stone Holder**

4.915 - 5.380" (124.84 - 136.65mm) set of 6 (Requires Sleeve 514-9-4G)

**514-9-31K Stone Holder**

5.165 - 5.630" (131.19 - 143.00mm) set of 6 (Requires Sleeve 514-9-4G)



514-9-31L Stone Holder

5.415 - 5.880" (137.54 - 149.35mm) set of 6 (Requires Sleeve 514-9-4G)

**514-9-31M Stone Holder**

5.665 - 6.130" (143.89 - 155.70mm) set of 6 (Requires Sleeve 514-9-4G)

**514-9-31N Stone Holder**

5.915 - 6.380" (150.24 - 162.05mm) set of 6 (Requires Sleeve 514-9-4G)



514-9-31P Stone Holder

6.165 - 6.630" (156.59 - 168.40mm) set of 6 (Requires Sleeve 514-9-4G)

**514-9-31Q Stone Holder**

6.415 - 6.880" (162.94 - 174.75mm) set of 6 (Requires Sleeve 514-9-4G)

**514-9-31R Stone Holder**

6.665 - 7.130" (169.29 - 181.10mm) set of 6 (Requires Sleeve 514-9-4G)



514-9-31S Stone Holder

6.915 - 7.380" (175.64 - 187.45mm) set of 6 (Requires Sleeve 514-9-4G)



Diamond Abrasives for Rottler Precision 6 Stone Holder Hone Heads

NOTE: Ra - Roughness Average. Value before Ra is in micro inches. Value in brackets um is micro meters. Long designates length of stone. Height designated thickness of stone.

Diamond Stones, .312 (7.90MM), Set of 6

514-9-32F Diamond Stones, 80 grit

3" (76mm) long set of 6, 90 Ra, (2.25um)



514-9-32R Diamond Stones 80 grit

3.5" (89mm) long set of 6, 90 Ra, (2.25um)



514-9-32W Diamond Stones, 140/170 grit
 3" (76mm) long set of 6, 50-75 Ra, (1.25 - 1.875um)

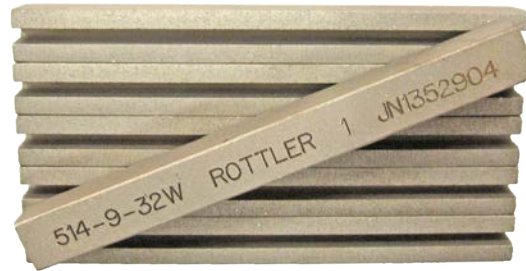

514-9-32K Diamond Stones, 170/200 grit
 3" (76mm) long set of 6, 45-60 Ra, (1.125 - 1.5um)



514-9-32J Diamond Stones, 270/325 grit
 3" (76mm) long set of 6, 35-45 Ra, (.875 - 1.125um)



514-9-32E Diamond Stones, 325/400 grit
 3" (76mm) long set of 6, 24-30 Ra, (.6 - .75um)



514-9-32C Diamond Stones, 500 grit
3" (76mm) long set of 6, 18-22 Ra, (.45 - .55um)



514-9-32L Diamond Stones, 550 grit
3" (76mm) long set of 6, 15-19 Ra, (.375 - .475)



514-9-32G Diamond Stones, 600 grit
3" (76mm) long set of 6, 8-12 Ra, (.2 - .3um)



514-9-33 Diamond Stones, 800 grit
3" (76mm) long set of 6



514-9-33C Diamond Stones, 800 grit
4" (102mm) long set of 6

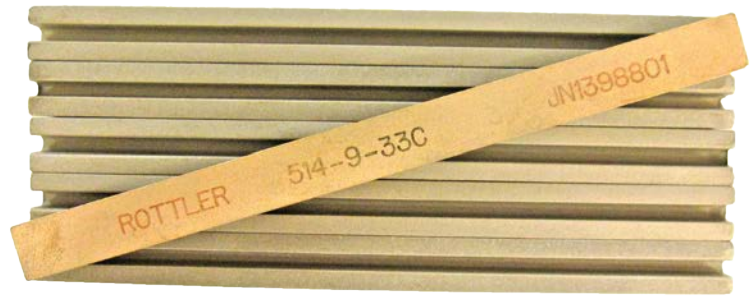

514-9-33J Diamond Stones, 1200 grit
3" (76mm) long set of 6



Diamond Stones, .200 (5.08MM), Set of 6

514-9-33B Diamond Stones, 270/325 grit
3.5" (89mm) long set of 6, 35-45 Ra,



514-9-32D Diamond Stones, 325/400 grit
3" (76mm) long set of 6, 18-22 Ra, 2.795 bore



514-9-33A Diamond Stones, 800 grit
3.5" (89mm) long set of 6

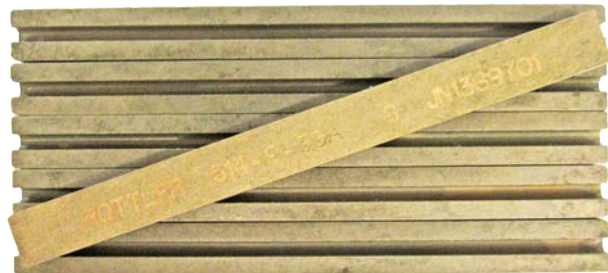

CBN Stones for Super Finishing with Rottler Precision 4 and 6 Stone Holder Hone Heads

514-9-35C CBN Stones, 320 grit
3" (76mm) long set of 4, for super finishing



514-9-35D CBN Stones, 400 grit
3" (76mm) long set of 4, for super finishing



514-9-35B CBN Stones, 600 grit
3" (76mm) long set of 4, for super finishing



Brushes for Plateau Finishing with Rottler Precision 4 and 6 Stone Holder Hone Heads**514-9-14H Brushes, for Plateau Finishing**

.550" (14mm) height, 3 1/2" (89mm) long, requires one or two size smaller stone holder compared to .312" (7.90mm) height diamond stone. Set of 4

**514-9-14Y Brushes, for Plateau Finishing**

.395" (10mm) height, 3 1/2" (89mm) long, requires same or one size smaller stone holder compared to .312" (7.90mm) height diamond stone. Set of 4



Large 4 Stone Holder Hone Head 2.770" - 7.38" (70.36mm - 187.45mm) Bore Diameter Range

514-9P Large Rottler Precision Heavy Duty 4 Stone Holder Hone Head Assembly

Without sleeves and stone holders - H80 Series Quick Change for cylinders up to 13" (330mm) long



514-9R Large Rottler Precision Heavy Duty 4 Stone Holder Hone Head Assembly

Without sleeves and stone holders - H80 Series Quick Change extended 2" (50mm) for cylinders longer than 13" (330mm)



Sleeves and Stone Holders for above Hone Head Assemblies

Bore diameter ranges listed below are with .312" (7.92mm) height diamond stones. For smaller diameter range, .200" (5.2mm) height diamond stones should be used.

514-9-4A Sleeve Assembly

2.770" - 3.880" (70.36 - 98.55mm)



514-9-6J Stone Holders

2.990 - 3.44" (75.95 - 87.38mm) set of 4 (Requires Sleeve 514-9-4A)

Note: To hone diameter 2.77" (70.36mm) use .200" (5.1mm) height Stone Set with 514-9-6J Stone Holders

**514-9-6A Stone Holders**

3.165 - 3.630" (80.39 - 92.20mm) set of 4 (Requires Sleeve 514-9-4A)

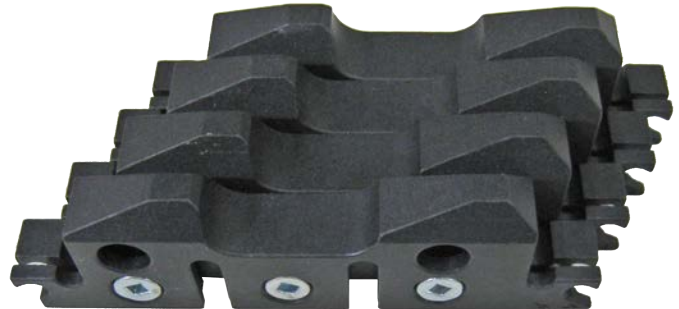
**514-9-6B Stone Holders**

3.415 - 3.880" (86.74 - 98.55mm) set of 4 (Requires Sleeve 514-9-4A)



514-9-4B Sleeve Assembly
3.500 - 4.670" (88.00 - 118.62mm)



514-9-6C Stone Holders
3.665 - 4.130" (93.09 - 104.90mm) set of 4 (Requires Sleeve 514-9-4B)

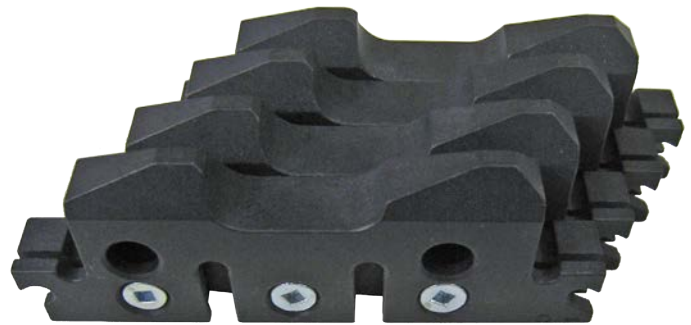

514-9-6D Stone Holders
3.915 - 4.380" (99.44 - 111.25mm) set of 4 (Requires Sleeve 514-9-4B)



514-9-6E Stone Holders

4.165 - 4.630" (105.79 - 117.60mm) set of 4 (Requires Sleeve 514-9-4B)



514-9-4C Sleeve Assembly

4.250 - 7.380" (107.95 - 187.45mm)



514-9-6F Stone Holders

4.415 - 4.880" (112.14 - 123.95mm) set of 4 (Requires Sleeve 514-9-4C)



514-9-6G Stone Holders

4.665 - 5.130" (118.49 - 130.30mm) set of 4 (Requires Sleeve 514-9-4C)

**514-9-6H Stone Holders**

4.915 - 5.380" (124.84 - 136.65mm) set of 4 (Requires Sleeve 514-9-4C)

**514-9-6K Stone Holders**

5.165 - 5.630" (131.19 - 143.00mm) set of 4 (Requires Sleeve 514-9-4C)

**514-9-6L Stone Holders**

5.415 - 5.880" (137.54 - 149.35mm) set of 4 (Requires Sleeve 514-9-4C)



514-9-6M Stone Holders

5.665 - 6.130" (143.89 - 155.70mm) set of 4 (Requires Sleeve 514-9-4C)

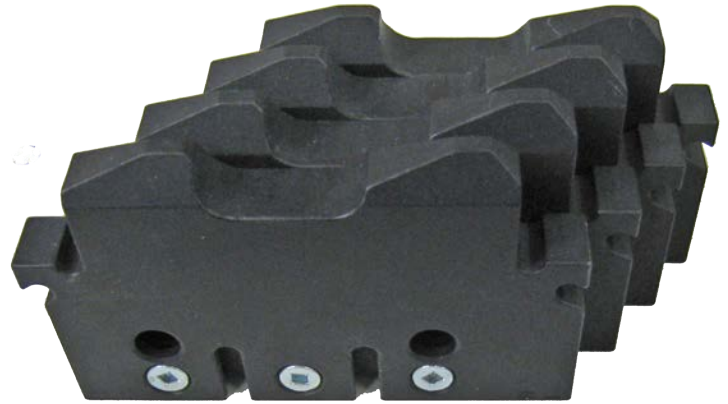
**514-9-6N Stone Holders**

5.915 - 6.380" (150.24 - 162.05mm) set of 4 (Requires Sleeve 514-9-4C)

**514-9-6P Stone Holders**

6.165 - 6.630" (156.59 - 168.40mm) set of 4 (Requires Sleeve 514-9-4C)



514-9-6Q Stone Holders

6.415 - 6.880" (162.94 - 174.75mm) set of 4 (Requires Sleeve 514-9-4C)

**514-9-6R Stone Holders**

6.665 - 7.130" (169.29 - 181.10mm) set of 4 (Requires Sleeve 514-9-4C)

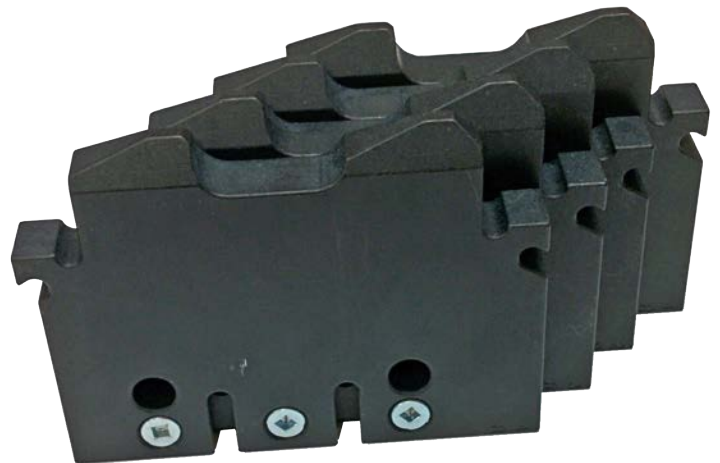
**514-9-6S Stone Holders**

6.915 - 7.380" (175.64 - 187.45mm) set of 4 (Requires Sleeve 514-9-4C)



Diamond Abrasives for Rottler Precision 4 Stone Holder Hone Heads

NOTE: Ra - Roughness Average. Value before Ra is in micro inches. Value in brackets um is micro meters. Long designates length of stone. Height designated thickness of stone.

Diamond Stones, .312" (7.90mm) Height, Set of 4

514-9-14F Diamond Stones, 80 grit
 3" (76mm) long set of 4, 90Ra (2.25um), stock removal .004-.007/min.



514-9-14R Diamond Stones, 80 grit
 3 1/2" (89mm) long set of 4, 90Ra (2.25um), stock removal .004-.007/min. (.102 - .178mm)

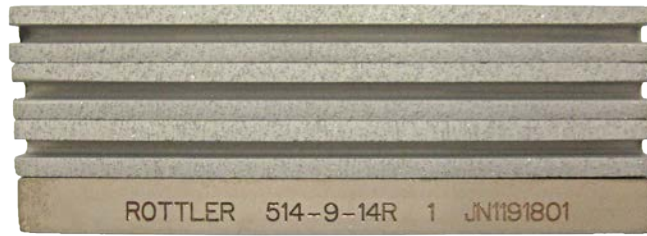

514-9-21R Diamond Stones, 80 grit
 4" (102mm) long set of 4, 90 Ra, (2.25um)



514-9-14W Diamond Stones, 140/170 grit
 3" (76mm) long set of 4, 50-75Ra (1.25 - 1.875um)

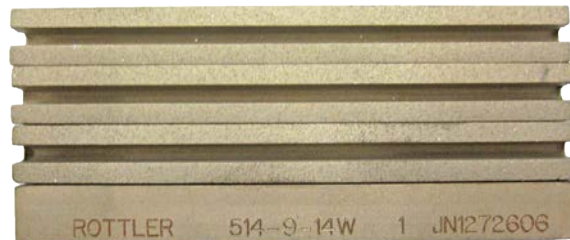

514-9-21W Diamond Stones, 140/170 grit
 4" (102mm) long set of 4, 50-75 Ra, (1.25 - 1.875um)



514-9-14K Diamond stones, 170/200 grit
 3 (76mm) long set of 4, 45-60Ra (1.125 - 1.5um)



514-9-14M Diamond Stones, 170/200 grit
 3 1/2" (89mm) long set of 4, 45-60Ra (1.125 - 1.5um)



514-9-21M Diamond stones, 170/200 grit
 4" (102mm) long set of 4, 45-60 Ra, (1.125 - 1.5um)



514-9-14J Diamond Stones, 270/325 grit
 3" (76mm) long set of 4, 35-45Ra (.875 - 1.125um)



514-9-14T Diamond Stones, 270/325 grit
3 1/2" (89mm) long set of 4, 35-45Ra (.875 - 1.125um)



514-9-14Z Diamond Stones, 270/325 grit
4" (102mm) long set of 4, 35-45Ra (.875 - 1.125um)



514-9-14E Diamond Stones, 325/400 grit
3" (76mm) long set of 4, 24-30Ra (.6 - .75um)



514-9-14Q Diamond Stones, 325/400 grit
3 1/2" (89mm) long set of 4, 24-30Ra (.6 - .75um)

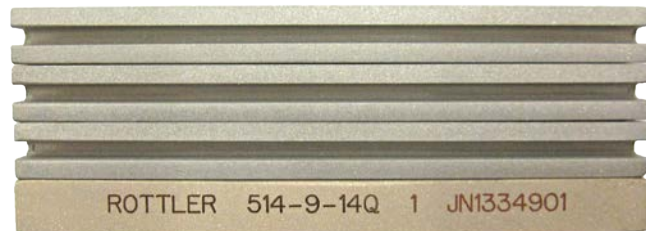

514-9-14X Diamond Stones, 325/400 grit
4" (102mm) long set of 4, 24-30Ra (.6 - .75um)



514-9-14V Diamond Stones, 400 grit
 3" (76mm) long set of 4, 15-19Ra (.375 - .475um)



514-9-14C Diamond Stones, 500 grit
 3" (76mm) long set of 4, 18-22Ra (.45 - .55um)

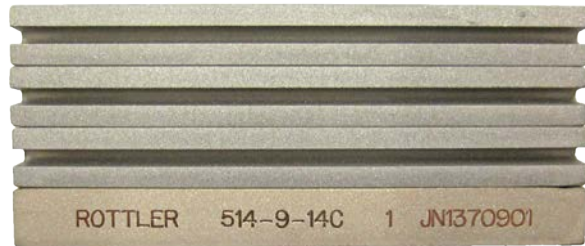

514-9-14P Diamond Stones, 500 grit
 3-1/2" (89mm) long set of 4, 18-22Ra (.45 - .55um)



514-9-14D Diamond Stones, 325/400 grit
 3" (76mm) long set of 4, 18-22Ra (.45 - .55um)
 Special required for bores under 2.990" diameter
 (75.94mm) .200" (5.1mm) Height



514-9-14U Diamond Stones, 500 grit
 2 1/2" (64mm) long set of 4, 18-22Ra (.45 - .55um)

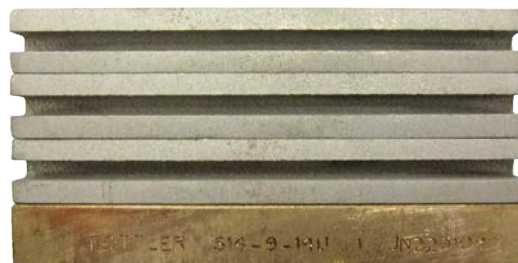

514-9-14L Diamond Stones, 550 grit
 3" (76mm) long set of 4, 15-19Ra (.375 - .475um)



514-9-14N Diamond Stones, 550 grit
 3 1/2" (89mm) long set of 4, 15-19Ra (.375 - .475um)



514-9-14G Diamond Stones, 600 grit
 3" (76mm) long set of 4, 8-12Ra (.2 - .3um)



514-9-14S Diamond Stones, 600 grit
 3 1/2" (89mm) long set of 4, 8-12Ra (.2 - .3um)



514-9-21G Diamond Stones, 800 grit
 3" (76mm) long set of 4



514-9-21H Diamond Stones, 1000 grit
3" (76mm) long set of 4



514-9-21J Diamond Stones, 1200 grit
3" (76mm) long set of 4



CBN Stones for Super Finishing with Rottler Precision 4 and 6 Stone Holder Hone Heads

514-9-35C CBN Stones, 320 grit
3" (76mm) long set of 4, for super finishing



514-9-35D CBN Stones, 400 grit
3" (76mm) long set of 4, for super finishing



514-9-35B CBN Stones, 600 grit
3" (76mm) long set of 4, for super finishing



Brushes for Plateau Finishing with Rottler Precision 4 and 6 Stone Holder Hone Heads**514-9-14H Brushes, for Plateau Finishing**

.550" (14mm) height, 3 1/2" (89mm) long. Set of 4

Requires one or two size smaller stone holder compared to .312" (7.90mm) height diamond stone.

**514-9-14Y Brushes, for Plateau Finishing**

.395" (10mm) height, 3 1/2" (89mm) long. Set of 4

Requires same or one size smaller stone holder compared to .312" (7.90mm) height diamond stone.



Special Stones for Finishing Aluminum Silicone Cylinders
 (Refer to bulletin No. 284) Requires Rottler Precision 4 or 6 Stone Holder Hone Heads

514-9-18P Special Red Finish Diamonds
 For Final Sizing (set of 4)



514-9-18N Silicone Abrasive Exposing Stones
 For Removing Aluminum (set of 4)



514-9-21 Polishing Felt Pads
 For use with 514-9-21F silicon paste. (set of 4)



514-9-21F Silicone Paste
 For use with 514-9-21 Polishing felt pads



**Special Hone Heads - Additional diameter range not listed available on request
Special Hone Head, Dual Stage, 6 Diamonds and 4 Plateau Brushes**

514-9M Hone Head, Dual Stage Rough & Finish (10 Stone)

3.9" - 4.1" (99.06MM - 104.14MM)



Special Hone Head 514-9M Dual Stage, Diamond Stones, Set of 6

110-162R Dual Stage Diamond Stones

.0781" Tall (19.83MM), (325/400 Grit) Set of 6



110-163R Dual Stage Diamond Stones

.859" Tall (22.73MM), (325/400 Grit) Set of 6

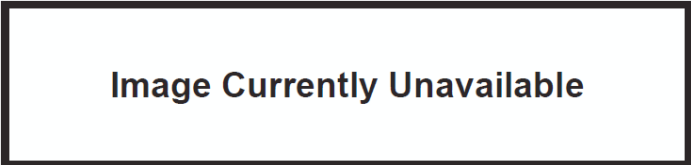

110-163R-01 Dual Stage Diamond Stones

.859" Tall (22.73MM), (140/170 Grit)

3.865" Bore, Set of 6

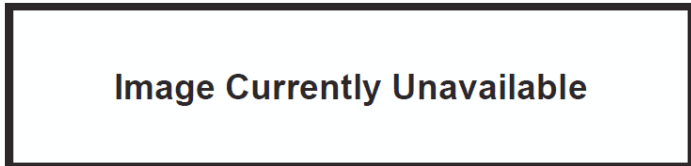

110-163R-03 Dual Stage Diamond Stones
.859" Tall (22.73MM), 600 Grit
3.865" Bore, Set of 6

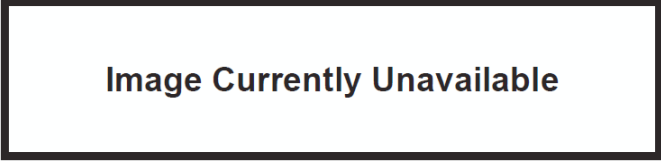

110-164R Dual Stage Diamond Stones
.937" Tall (23.80MM), (325/400 Grit) Set of 6

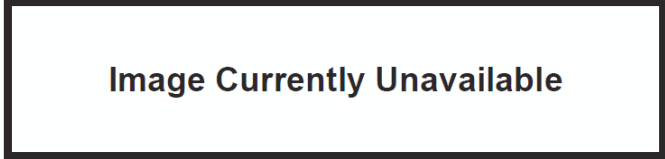

110-164R-01 Dual Stage Diamond Stones
.937" Tall (23.80MM), (140/170 Grit)
4.110" Bore, Set of 6

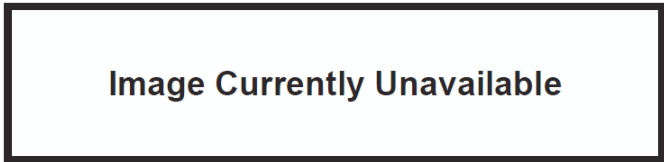

110-164R-03 Dual Stage Diamond Stones
.937" Tall (23.80MM), 60 Grit
4.110" Bore, Set of 6

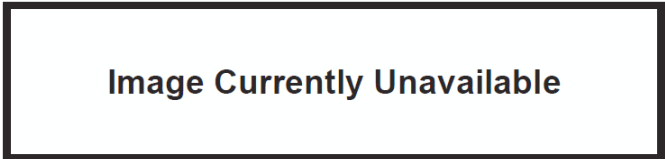

Special Dual Stage Hone Head Brush Sets

124-24 Brush Set, Dual Stage Hone Head
.781 Tall (19.84MM) Set of 4

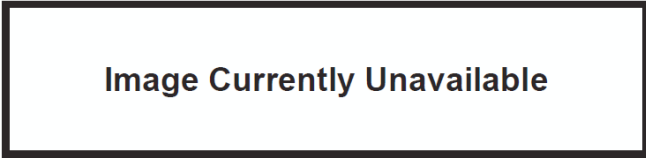

124-25 Brush Set, Dual Stage Hone Head
.859 Tall (21.82MM) Set of 4

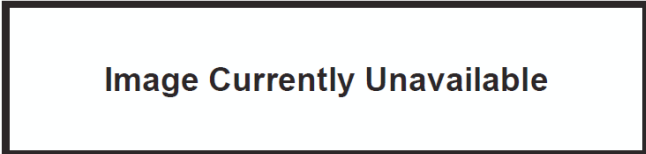

124-26 Brush Set, Dual Stage Hone Head
.937 Tall (23.80MM) Set of 4

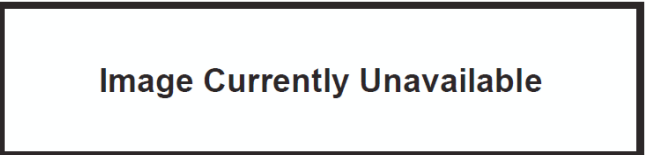

Special Hone Head Single Stage, 12 Stone

514-9N Hone Head, Single Stage (12 Stone)

3.9" - 4.375" (99.06MM - 111.125MM), H-70



110-171-01 Single Stage Diamond Stones

.0781" Tall (19.83MM), 600 Grit Set of 12



110-171-02 Single Stage Diamond Stones

.0781" Tall (19.83MM), 1200 Grit, Set of 12



110-171-03 Single Stage Diamond Stones

.0781" Tall (19.83MM), (325/400 Grit) - Set of 12



Special Hone Head, 1.97" - 2.32" (50mm - 59mm) , 6 Stone Holder

LO-6568-161 Hone Head, Single Stage (6 Stone)

1.97" - 2.32" (50MM - 59MM)

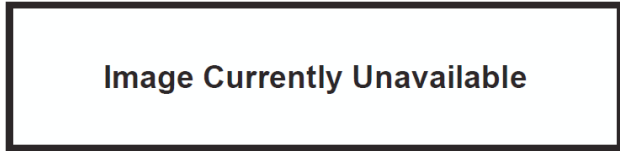

110-174-01 Diamond Stones

.25 x .640 x 4.25 (6.35MM x 16.26MM x 107.95MM)
(325/400 Grit) - Set of 5



Special Hone Head, 1.69" - 1.93" (43 - 49mm) , 5 Stone Holder

LO-6568-160 Hone Head, Single Stage

(5 Stone) 1.69" - 1.93" (43MM - 49MM)

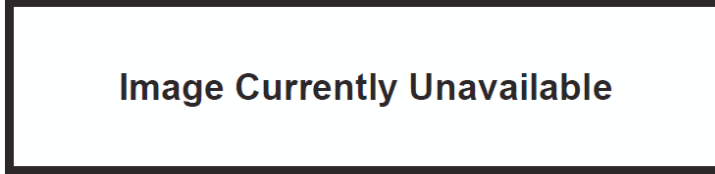

110-173-01 Diamond Stones

.25 x .5 x 4.25 (6.35MM x 12.7MM x 107.95MM)
(325/400 Grit) - Set of 5



Optional Measuring Equipment

201 Mitutoyo Surface Tester Surfptest 201



514-8-27 Stone Depth Scale and Holder Assembly (inch)

514-8-27F Stone Depth Scale and Holder Assembly (metric)

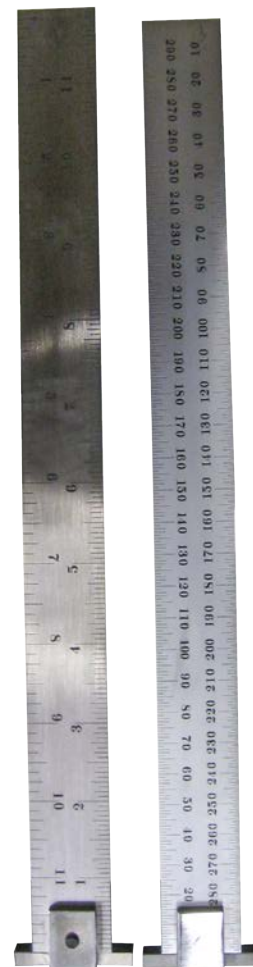

Camera & Software To View Cross Hatch Angle



514-14-29A Camera



514-14-29B Software Package

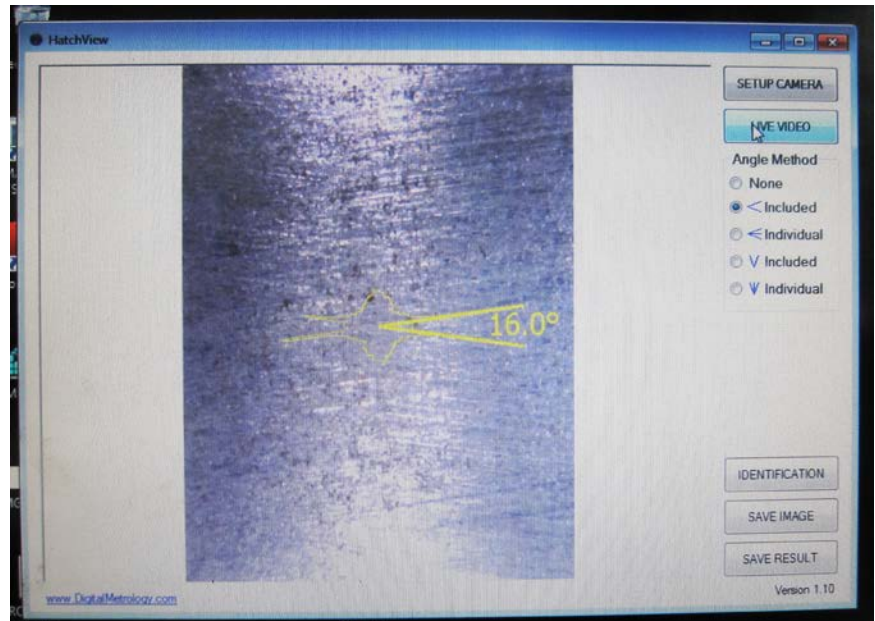

Adapter for Pin Hone Mandrels

514-9V Adapter

To drive universal honing mandrels such as Sunnen and Delapena



Safety Shut Down Protection System

514-13-26 Laser Light Curtain

Covering front opening of machine enclosure

